

Sentryum



DATACENTER



E-MEDICAL



EMERGENCY



INDUSTRY



TRANSPORT



ONLINE



Tower



Energy Share



Service 1st start



SmartGrid ready



Supercaps UPS



USB plug

1-3:1 10-20 kVA/kW
3:3 10-120 kVA/kW



HIGHLIGHTS

- **Extensive range of solutions**
- **Compactness**
- **Efficiency up to 96.6%**
- **High power availability**
- **Smart battery management**
- **Maximum reliability**
- **Flexibility of use**
- **Graphic touch screen display**

The rapid evolution of IT technologies, additional focus on environmental matters and complexity of critical applications lead to a need for more flexible, efficient, secure and interconnected power protection solutions.

The Sentryum 10-120 kVA/kW offers the best combination of power availability, energy efficiency and global performance ensuring installation and running cost savings. It is the very latest Riello UPS development resulting in a third-generation transformer-free UPS, originally introduced into the market over twenty three years ago. This ultimate solution is rated at output power factor 1 and defined as ON LINE double conversion technology in accordance with VFI-SS-111 classification (as set out in standard IEC

EN 62040-3). The Sentryum series is a transformer-free UPS available in 10-15-20 kVA/kW models with three-phase/single-phase input and single-phase output and 10-15-20-30-40-60-80-100-120 kVA/kW models with three-phase input and output.

Sentryum is designed and built using state-of-the-art technology and components. It applies the advanced technologies such as a DSP (Digital Signal Processor), dual core microprocessors, three-level inverter circuits and resonant controls to provide maximum protection to critical loads with no impact on downstream systems, all whilst maintaining optimised energy savings. With a unique control system, it makes it possible to reduce the inverter

output harmonic voltage distortion (<1% at resistive linear load and <1.5% at non-linear load) and provide a rapid response to all load variations, ensuring an outstanding sinewave form during all conditions.

Furthermore, Riello UPS' technological advances in digital control and power components contribute to minimise the impact on the grid.

Sentryum provides the solution to installation problems in systems where the mains electricity supply has limited power available, where the UPS is supported by a generator, or where there are compatibility problems with loads that generate harmonic currents.

EXTENSIVE RANGE OF SOLUTIONS

Sentryum has been conceived to optimise the specific requirements by enhancing the installation flexibility.

Riello UPS offers Sentryum in four different frame solutions to satisfy any critical power demand and application. Three of the frame types are available for the Sentryum 10-60 kVA/kW power ratings:

Compact (CPT): this cabinet frame is specifically devised to offer a compact but efficient solution for tailored applications; thanks to the ultimate technologies applied, this solution offers unmatched power (up to 20 kVA @ pf 1) and autonomy (12 minutes of backup time at typical load) in an extremely reduced space.

Active (ACT): this solution offers an optimised degree of flexibility to meet different power requirements and battery autonomies. The solution offered is extremely compact but exceptionally powerful, with the possibility to deliver up to 60 kVA (@ pf 1). The ACT model allows to build one or two levels of internal battery backup time (NB this does not apply to the 60 kVA/kW model, which does not allow the installation of internal batteries).

Xtend (XTD): this version is the most flexible solution available to meet various installation requirements and power demands. In an extremely small footprint, it is possible to build up to three-levels of battery backup time. In addition, the mechanical design makes it possible to install an isolation transformer or easily change the degree of protection from IP20 to IP21 or even IP31. The installation of a dedicated optional seismic kit allows the XTD model to become compliant to ICC-ES AC 156 (2020) too.

The fourth frame is unique for the Sentryum 80-120 kVA/kW power ratings:



Rear view Sentryum Compact.

S3T 80, S3T 100, S3T 120. The layout of these models doesn't allow for the installation of internal batteries and transformers. However, as per the XTD model, the mechanical design does make it possible to easily change the degree of protection from IP20 to IP21 or even IP31. In addition, the S3T 80-120 models can become compliant to ICC-ES AC 156 (2020) simply by adding the optional seismic kit.

COMPACTNESS

Modern guidelines and sustainable best practices direct us to conceive and design UPS with a particular focus on the entire product life cycle, applying ultimate but resilient technologies, recyclable materials and miniaturisation of assemblies whilst ensuring the systems' global reliability, which is pivotal for any UPS. The internal card layout has been optimised to reduce the number of components, interconnections and space required, whilst at the same time increasing reliability and Mean Time Between Failures (MTBF), which helps to minimise operational expenditure such as service operations and maintenance costs.

The result is an outstanding range of four different solutions providing powerful but compact designs as follows:

Sentryum 10-60 kVA/kW power ratings

- **Compact:** less than 0.25 m² footprint and only 0.17 m³ of volume.
- **Active:** less than 0.35 m² footprint and only 0.33 m³ of volume.
- **Xtend:** less than 0.4 m² footprint and less than 0.5 m³ of volume.

Sentryum 80-120 kVA/kW power ratings

- **S3T 80, S3T 100, S3T 120:** less than 0.42 m² footprint and less than 0.67 m³ of volume.



Graphic touch screen display.

MECHANICAL CHARACTERISTICS	SENTRYUM COMPACT-CPT (10-20)	SENTRYUM ACTIVE-ACT (10-60)	SENTRYUM XTEND-XTD (10-60)	SENTRYUM S3T 80-120 (80-120)
Cabinet layout description	Free standing type with wheels and terminals/ switches on rear	Free standing type with wheels and terminals/ switches on front	Free standing type with wheels and terminals/ switches on front	Free standing type with wheels and terminals/ switches on front
Range [kVA/kW]	10-15-20 (1 Ph) 10-15-20 (3 Ph)	10-15-20 (1 Ph) 10-15-20-30-40-60 (3 Ph)	10-15-20 (1 Ph) 10-15-20-30-40-60 (3 Ph)	80-100-120 (3 Ph)
Battery	Space for: 40 blocks	Space for: 2x40 blocks (No internal battery for 60kVA)	Space for: 3x40 blocks (3x40x9Ah for 60kVA model, not 7Ah)	No internal battery
Ventilation	Forced, front to rear	Forced, front to rear	Forced, front to rear (Air filter door as option)	Forced, front to rear (Air filter door as option)
Cabinet IP rating	IP20 finger proof (either with cabinet doors open or closed)	IP20 finger proof (either with cabinet doors open or closed)	IP20 finger proof (either with cabinet doors open or closed) IP21/31 as option	IP20 finger proof (either with cabinet doors open or closed) IP21/31 as option
Cable input	Bottom (rear)	Bottom (front)	Bottom (front)	Bottom (front)

HIGH EFFICIENCY

Sentryum is a true ON LINE double conversion UPS system providing the very highest levels of power availability, flexibility and unrivalled energy efficiency with superior performance for any small Data Center and mission critical applications.

With a full power rating (kVA=kW unity pf), the Sentryum provides the maximum available power without any de-rating. Thanks to the three-level IGBT inverter topology (constructed using modules rather than discrete components) and innovative digital controls, the Sentryum provides up to 96.6% overall efficiency, whilst maintaining a reduced number of components, connections and ribbon cables, which increases the overall system reliability thanks to a higher MTBF.

Riello UPS' advanced average current mode digital PFC control and state-of-the-art three-level NPC inverters work at high frequency (18 kHz for 10-60 kVA/kW, 16kHz for 80-120 kVA/kW), which contributes to minimising the UPS's impact on the grid and helps to reduce the overall operational costs and energy bills.

Sentryum applies a zero impact onto its power source, whether this is from the mains power supply or a generator, this results in:

- Very low input current distortion <3%;
- Near unity input power factor 0.99;
- Power walk-in function that ensures progressive rectifier start up;
- Start up delay function, to sequentially restart the rectifiers once the mains power supply is restored if there are

several UPS within the overall system;;

- In addition, Sentryum provides a filtering and power factor correction function within the power network upstream of the UPS, thus eliminating harmonic components and reactive power generated by the power utilities.

HIGH POWER AVAILABILITY

Sentryum's fully rated design delivers full power (kVA=kW) regardless of the load power factor or operating temperature (full-rated power is available up to 40 °C). Furthermore, Sentryum's advanced digital control makes it possible to deliver up to 270% inverter current for 200 ms and 150% for 300 ms. This high overcurrent availability enables the system to deal with sudden peak loads (without static bypass intervention) and provide the short circuit current if required during operation on battery.

The innovative input stage design provides extremely high battery recharging current, whilst at the same time an energy efficient conversion process during battery operation to reduce the power wasted and to increase the autonomy time compared to legacy DC/AC converters.

SMART BATTERY MANAGEMENT

Proper battery care is critical to ensure the correct operation of the UPS during emergency conditions. The Riello UPS Smart Battery Management system consists of a series of features and capabilities to optimise battery management and obtain the best performance and operating life possible.

Battery recharging: Sentryum is suitable for use with conventional hermetically sealed lead-acid (VRLA), AGM and GEL batteries, Open Vented and Nickel Cadmium batteries.

Sentryum is also compatible with alternative backup power sources such as Li-Ion batteries and Supercapacitors.

Its superior battery charging current availability, i.e. up to 30 Amperes for the 40-120 kVA/kW power range, means that the Sentryum can be utilised within any extended battery autonomy application. Depending on the battery type, different charging methods are available:

- One-level voltage recharge, typically used for widely available VRLA AGM batteries.
- Two-level voltage recharge according to IU specification.
- Cyclical recharge system to reduce electrolyte consumption and lengthen the life of VRLA batteries.

The battery management system also incorporates:

- Recharge voltage compensation based on ambient temperature to prevent excessive battery charging or overheating.
- Battery tests to diagnose in advance any reduction in performance or problems with the batteries.
- Deep discharge protection: during extended low-load discharges, the end of discharge voltage is increased - as recommended by battery manufacturers - to prevent damage or reduced battery performance.
- Ripple current: recharge ripple current

(residual AC component at low frequency) is one of the main causes of reduced reliability and battery life. Using a high frequency battery charger, Sentryum reduces this value to negligible levels, prolonging battery life and maintaining high performance over a long period of time.

- Wide voltage range: the rectifier is designed to operate within a wide input voltage range (up to -40% at half load), reducing the need for battery discharge and thus helping to extend battery life.

Sentryum allows a wide battery block range per string; the standard 20+20 battery blocks @ 12 V with neutral central point can be adjusted from 15+15 to 22+22 battery blocks (nominal power de-rating is automatically applied below 20+20 battery block configuration).

MAXIMUM RELIABILITY AND AVAILABILITY

Distributed parallel configuration of up to 8 units per redundant (N+1) or capacity parallel system grants exceptional expandability. The UPS continue to operate in parallel even if the connection cable is interrupted (Closed Loop).

Advanced technology and use of high performance components allows Sentryum to provide exceptional performance and utmost reliability:

- The smallest overall footprint is only 0.35 m² for Sentryum 40 kVA/kW with two strings of 40 battery blocks;
- The input power stage (IGBT rectifier) ensures an input power factor close to 1 with extremely low current distortion, avoiding the need for bulky and expensive filters;
- The Sentryum's unity output power factor makes it suitable for any Data Center application ensuring full power availability without downgrading no matter the load power factor range (typically from 0.9 lagging to 0.9 leading);
- Extremely low output THDV under any circumstances provides a perfect sinewave and therefore a reliable power supply for the load preventing and disturbances from affecting the network users;
- More active power than a traditional UPS, guaranteeing a greater margin when sizing UPS for potential future load increases;
- More energy to face sudden load increase or clear output short circuits due to appliance failures downstream;
- Thanks to the principle of smart ventilation, Sentryum manages the fan speed and airflow in accordance with



the room temperature and load level.

This preserves the lifespan of the fans, whilst at the same time reduces noise levels and overall power consumption due to unnecessary UPS ventilation. Furthermore, the overall UPS high efficiency reduces any losses and the need for high levels of ventilation compared to older legacy UPS. This results in a decrease in the overall noise level at the nominal load and a reduction in the number of fans required, which significantly benefits the operating and maintenance costs.

- Fan failure monitoring: each fan is monitored individually for the 60-120 kVA/kW power ratings as standard, while this feature is a factory-fitted option for the 10-40 kVA/kW power ratings (available for Xtend version only). In the event of a fan failure, an alarm will be raised on the UPS display and via remote monitoring device (if present); this immediately informs the user so

that necessary actions can be taken to restore the system to correct operation..

FLEXIBILITY

With its flexible range of four solutions, configurations, performances, accessories and options, Sentryum is suitable for use in a wide range of applications:

- Suitable for powering capacitive loads, such as blade servers, without any reduction in active power from 0.9 lead to 0.9 lag;
- ON LINE, ECO, SMART ACTIVE and STANDBY OFF operating Modes - compatible with central power supply systems (CPSS) applications;
- Frequency Converter Mode;
- Cold Start to switch on the UPS even when there is no mains power present;
- S3T 20 XTEND version: cabinet (440x840x1320 mm WxDxH) for optimised solutions when medium to long-term runtimes are required (up to one hour back up time for a 20 kVA/kW at typical load rate);
- Parallel configuration up to 8 units for three-phase version;
- Optional temperature sensor for external battery cabinets, to assist recharge voltage compensation;



Sentryum S3T 120 with open door.

- High power battery chargers to optimise charge time in the event of long runtimes;
- Dual input mains power supply (not applicable on Compact, optional for Active and S3T 80-120, standard on Xtend version);
- Isolation transformers for modifying the neutral earthing (separate power sources), or for galvanic isolation between the input and output (optional inside Xtend, external for Compact, Active or S3T 80-120 versions);
- Mechanical fitting for a higher rating of IP protection either IP21 or IP31 on Xtend and S3T 80-120 versions;
- Air filter door on Xtend and S3T 80-120 versions to protect UPS placed in dusty environment;
- Compatibility with alternative backup energy sources rather than lead batteries (NiCd or Li-ion batteries or Supercapacitors);
- Different sized battery cabinets and capacities, for extended runtimes.

ADVANCED COMMUNICATIONS

Sentryum is equipped with a coloured graphic touch screen display providing UPS information, measurements, operating states and alarms in different languages. The default screen displays the UPS status, graphical indication of the energy path through the UPS and the operational condition of the various assemblies (rectifier, batteries, inverter, bypass) within the UPS.

Furthermore, the user interface includes a UPS status led bar which delivers immediate and clear information regarding the overall status of the UPS by changing the colour (light blue, dark blue, orange

and red) according with the operating mode and condition.

- Advanced multi-platform communications for all operating systems and network environments: PowerShield³ monitoring and shutdown software included for Windows operating systems 11, 10, 8, Hyper-V, Server 2022, 2019, 2016 and previous versions, Windows Server Virtualization Hyper-V, macOS, Linux, Citrix XenServer and other Unix operating systems;
- Compatible with VMware infrastructures to perform graceful shutdown of hosts and clusters; to perform Vmotion and prioritised shutdown of VM thanks to NetMan 208 Network card;
- Compatible with Nutanix and Syneto infrastructures to perform graceful shutdown of hosts; to perform prioritised shutdown of VM thanks to NetMan 208 Network card;
- Compatible with RielloConnect (remote monitoring service);
- RS232 port on RJ10 connector and USB ports;
- 2 slots for the installation of optional communications accessories such as network adaptors and volt free contacts etc;
- Embedded contact interface which includes 5 programmable inputs and 4 programmable outputs;
- R.E.P.O. Remote Emergency Power Off for switching off the UPS via a remote emergency button;
- Graphic display panel for remote connection.



Sentryum Xtend 60 with open door.



DETAILS

**COMPACT 10-20 kVA
(front)**

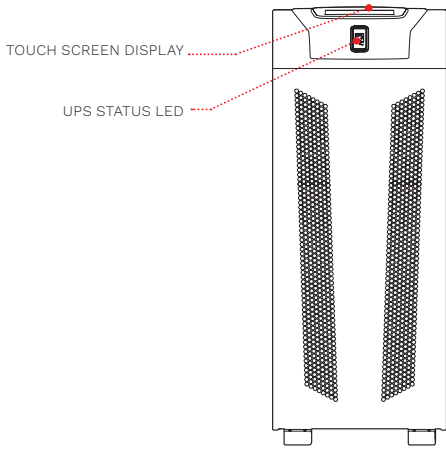

**COMPACT 10-20 kVA
(rear)**

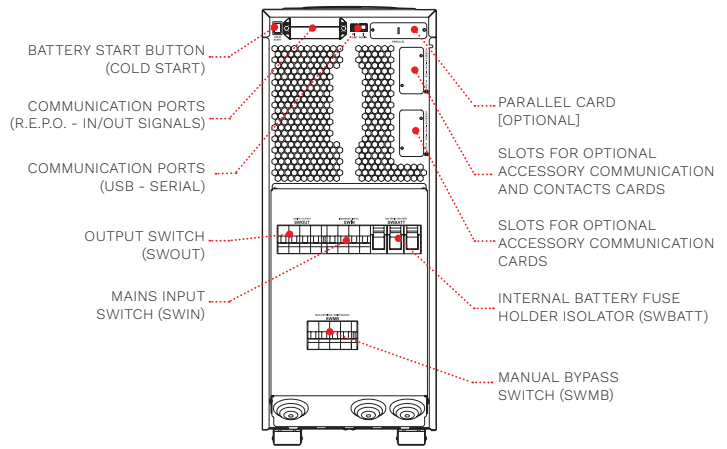

**ACTIVE 10-40 kVA
(front)**

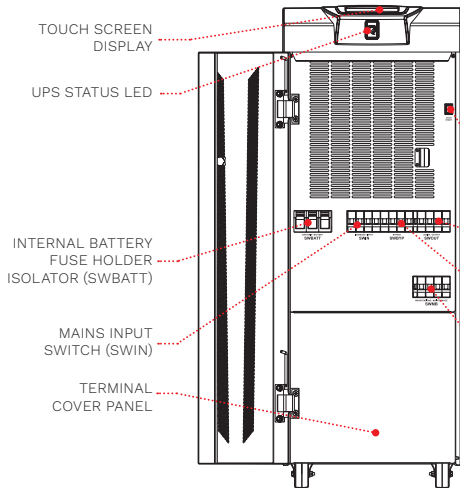

**ACTIVE 10-40 kVA
(rear)**

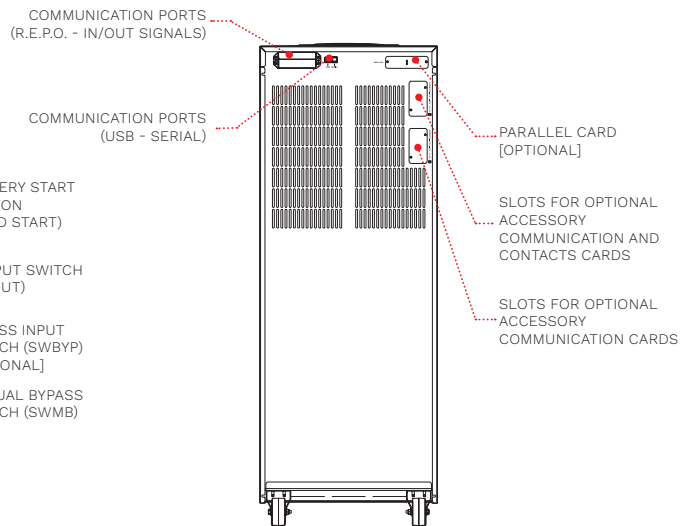

**ACTIVE 60 kVA
(front)**

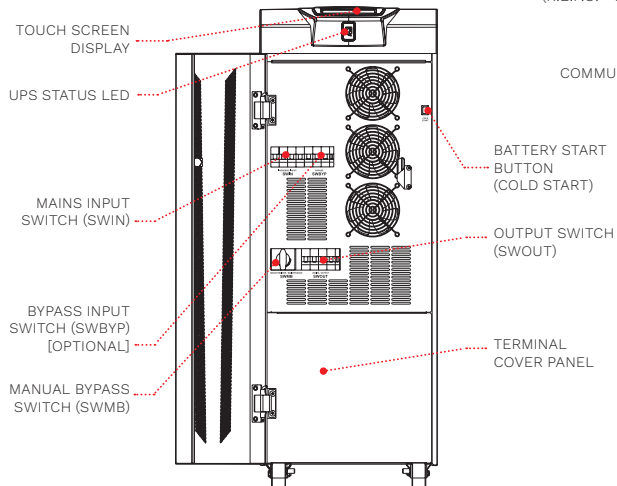

**ACTIVE 60 kVA
(rear)**

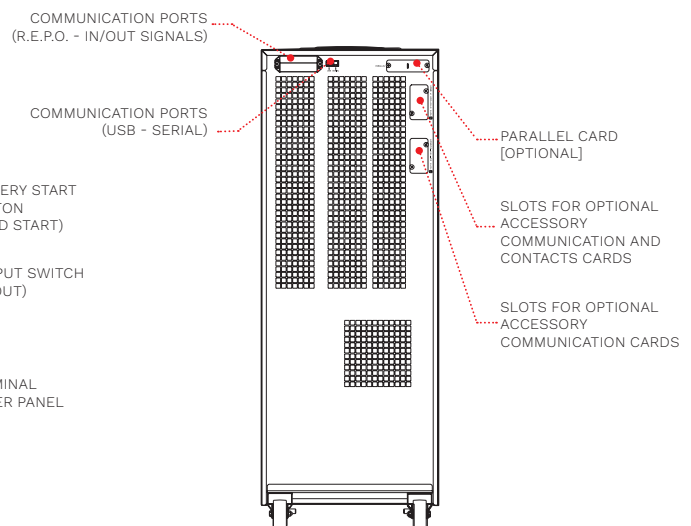

DETAILS

**XTEND 10-40 kVA
(front)**

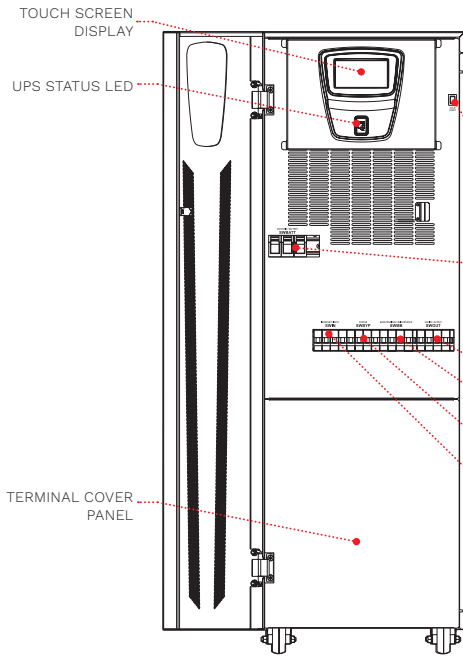

- TOUCH SCREEN DISPLAY
- UPS STATUS LED
- TERMINAL COVER PANEL

- BATTERY START BUTTON (COLD START)
- INTERNAL BATTERY FUSE HOLDER ISOLATOR (SWBATT)
- OUTPUT SWITCH (SWOUT)
- MANUAL BYPASS SWITCH (SWMB)
- BYPASS INPUT SWITCH (SWBYP)
- MAINS INPUT SWITCH (SWIN)

**XTEND 10-40 kVA
(rear)**

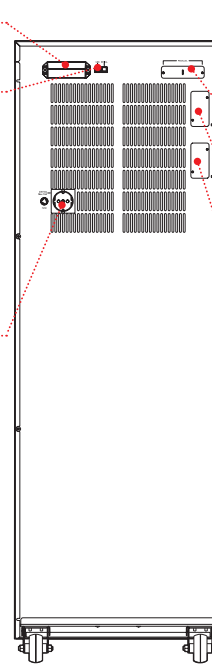

- COMMUNICATION PORTS (R.E.P.O. - IN/OUT SIGNALS)
- COMMUNICATION PORTS (USB - SERIAL)
- SCHUKO SOCKET (10 A MAX)

- PARALLEL CARD [OPTIONAL]
- SLOTS FOR OPTIONAL ACCESSORY COMMUNICATION AND CONTACTS CARDS
- SLOTS FOR OPTIONAL ACCESSORY COMMUNICATION CARDS

**XTEND 60 kVA
(front)**

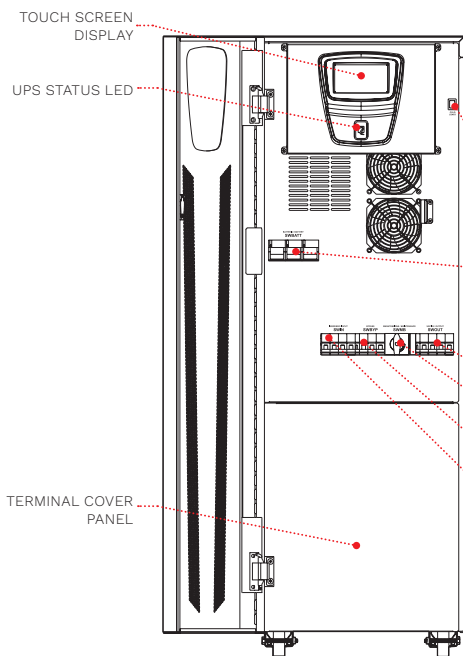

- TOUCH SCREEN DISPLAY
- UPS STATUS LED
- TERMINAL COVER PANEL

- BATTERY START BUTTON (COLD START)
- INTERNAL BATTERY FUSE HOLDER ISOLATOR (SWBATT)
- OUTPUT SWITCH (SWOUT)
- MANUAL BYPASS SWITCH (SWMB)
- BYPASS INPUT SWITCH (SWBYP)
- MAINS INPUT SWITCH (SWIN)

**XTEND 60 kVA
(rear)**

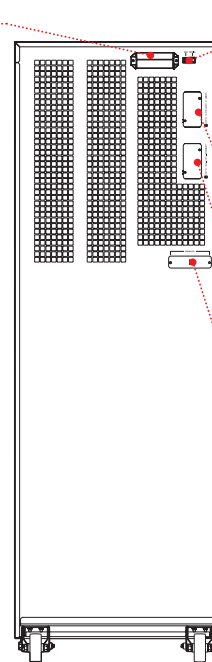

- COMMUNICATION PORTS (R.E.P.O. - IN/OUT SIGNALS)

- COMMUNICATION PORTS (USB - SERIAL)
- SLOTS FOR OPTIONAL ACCESSORY COMMUNICATION AND CONTACTS CARDS
- SLOTS FOR OPTIONAL ACCESSORY COMMUNICATION CARDS
- PARALLEL CARD [OPTIONAL]

DETAILS

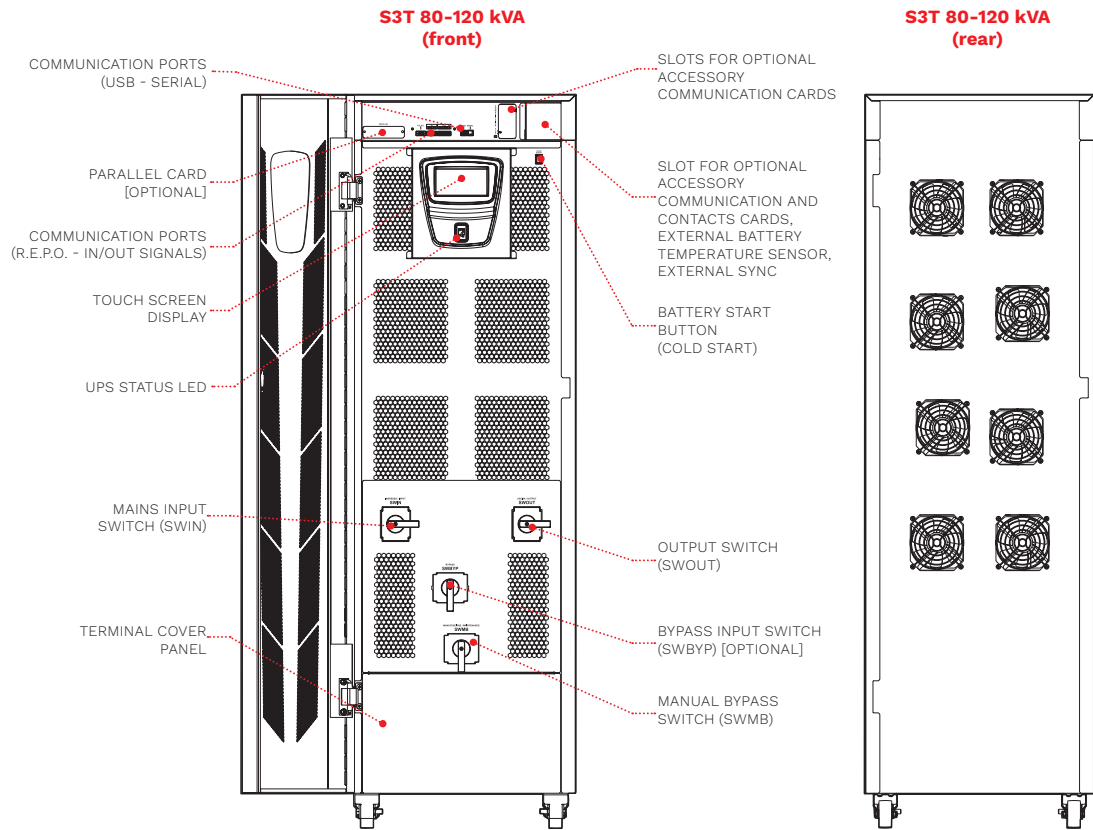

BATTERY CABINET

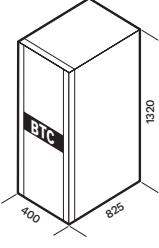
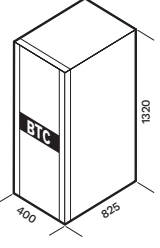
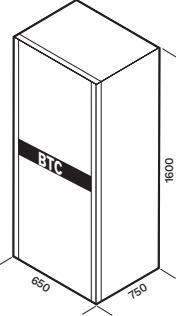
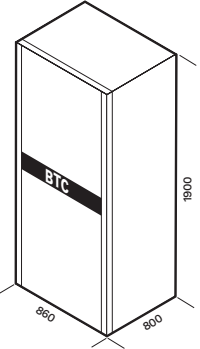
MODELS	BTC 1320 480V BB T4 3F BTC 1320 480V BB T2 3F BTC 1320 480V AB T5 3F	BTC 1320 480V BB T5 3F BTC 1320 480V AB T5 3F	BTC 1600 480V BB S5 3T BTC 1600 480V AB S5 3T	BTC 1900 480V BB V6 3T BTC 1900 480V BB V7 3T BTC 1900 480V BB V8 3T BTC 1900 480V BB V9 3T BTC 1900 480V AB V9 3T
UPS MODELS	S3M 10-20 kVA/kW ² S3T 10-40 kVA/kW ²	S3M 10-20 kVA/kW ² S3T 10-60 kVA/kW ²	S3M 10-20 kVA/kW ² S3T 10-80 kVA/kW ²	S3M 15-20 kVA/KW ² S3T 15-120 kVA/KW ²
Dimensions [mm]			 <i>Conditions apply on S3T 80 kVA/kW UPS model</i>	 <i>BTC 1900 480V BB V6 3T and BTC 1900 480V BB V7 3T: Conditions apply on S3T 120 kVA/kW UPS model</i>

² According with battery cabinet fuse associated.

OPTIONS

SOFTWARE

PowerShield³
PowerNetGuard

ACCESSORIES

NETMAN 208
MULTICOM 302
MULTICOM 352
MULTICOM 384
MULTICOM 411
MULTICOM 421
MULTI I/O
MULTIPANEL
MBB 100 A 2P
MBB 125 A 4P
MBB 400 A 4P

PRODUCT ACCESSORIES

Battery temperature sensor
ER battery charger
Parallel Kit
MULTICOM 392
UPS with internal isolation transformers (XTEND version)
IP rating IP21/IP31 (XTEND and S3T 80-120 versions)
Dual Input Kit (ACT and S3T 80-120 versions)
Front door air filter (XTD and S3T 80-120 versions)
Fan failure alarm for 10-40 kVA (XTD version)
Seismic kit (XTD and S3T 80-120 versions)
ENERGYMANAGER

MODELS	S3M CPT-ACT-XTD 10 ^{BAT}	S3M CPT-ACT-XTD 15 ^{BAT}	S3M CPT-ACT-XTD 20 ^{BAT}	S3T CPT-ACT-XTD 10 ^{BAT}	S3T CPT-ACT-XTD 15 ^{BAT}	S3T CPT-ACT-XTD 20 ^{BAT}
INPUT						
Rated voltage [V]	380 / 400 / 415 three-phase + N 220 / 230 / 240 single-phase + N			380 / 400 / 415 three-phase + N		
Rated frequency [Hz]	50 / 60					
Voltage tolerance [V]	230 / 400 ±20% @ full load ¹			400 ±20% @ full load ¹		
Frequency tolerance [Hz]	40 - 72					
Power factor @ full load	0.99					
Current distortion	THDI ≤3%					
BYPASS						
Rated voltage [V]	220 / 230 / 240 single-phase + N			380 / 400 / 415 three-phase + N		
Number of phases	1 + N			3 + N		
Voltage tolerance (ph-N) [V]	from 180 (adjustable 180-200) to 264 (adjustable 250-264) referring to neutral					
Rated frequency [Hz]	50 or 60 (selectable)					
Frequency tolerance	±5% (selectable)					
Bypass overload	110% infinite, 125% for 60 min, 150% for 10 min					
OUTPUT						
Nominal power [kVA]	10	15	20	10	15	20
Active power [kW]	10	15	20	10	15	20
Power factor	1 up to 40 °C					
Number of phases	1 + N			3 + N		
Rated voltage [V]	220 ¹ / 230 / 240 single-phase + N (selectable)			380 ¹ / 400 / 415 three-phase + N (selectable)		
Rated frequency [Hz]	50 or 60					
Frequency stability on battery operation	0.01%					
Voltage stability	±1%					
Dynamic stability	EN 62040-3 class performance 1 non-linear load					
Voltage distortion	<1% with resistive linear load / ≤1.5% with non-linear load					
BATTERIES						
Type	VRLA AGM/GEL/NiCd/Li-ion/SuperCaps					
Recharging method	One level, Two level, Cyclic recharge (selectable)					
OVERALL SPECIFICATIONS						
Weight without batteries [kg]						
CPT - ACT - XTD (10-60)	48-72-103	50-74-105	52-76-107	48-72-103	50-74-105	52-76-107
Weight [kg] S3T (80-120)	N.A.					
Dimensions CPT (10-20) (WxDxH) [mm]	Compact: 280x840x700					
Dimensions ACT (10-60) (WxDxH) [mm]	Active: 380x850x1025					
Dimensions XTD (10-60) (WxDxH) [mm]	Xtend: 440x840x1320					
Dimensions S3T 80-120 (WxDxH) [mm]	N.A.					
Communications	UPS status led bar - Graphic touch screen display - 2 slots for communications interface USB - RS232 - Contact interface with 5x opto insulated Input and 4x Output relays					
Ambient temperature for the UPS	0 °C - +40 °C					
Recommended temperature for battery life	+20 °C - +25 °C					
Range of relative humidity	5-95% non-condensing					
Colour	RAL 7016					
Noise level at 1 m [dBA ±2] SMART ACTIVE	<40					
IP rating	IP20					
SMART ACTIVE efficiency	up to 99%					
Standards	European directives: LV 2014/35/EU low voltage Directive EMC 2014/30/EU electromagnetic compatibility Directive Standards: Safety IEC EN 62040-1; EMC IEC EN 62040-2; RoHS compliant Classification in accordance with IEC EN 62040-3 (Voltage Frequency Independent) VFI - SS - 111					
Moving the UPS	Castors / pallet jack					

¹ For wider tolerance conditions apply.

^{BAT} Also available with internal batteries.

MODELS	S3T ACT-XTD 30 ^{BAT}	S3T ACT-XTD 40 ^{BAT}	S3T ACT-XTD 60 ^{BAT}	S3T 80	S3T 100	S3T 120
INPUT						
Rated voltage [V]	380 / 400 / 415 three-phase + N					
Rated frequency [Hz]	50 / 60					
Voltage tolerance [V]	400 ±20% @ full load ¹					
Frequency tolerance [Hz]	40 - 72					
Power factor @ full load	0.99					
Current distortion	THDI ≤3%					
BYPASS						
Rated voltage [V]	380 / 400 / 415 three-phase + N					
Number of phases	3 + N					
Voltage tolerance (ph-N) [V]	from 180 (adjustable 180-200) to 264 (adjustable 250-264) referring to neutral					
Rated frequency [Hz]	50 or 60 (selectable)					
Frequency tolerance	±5% (selectable)					
Bypass overload	110% infinite, 125% for 60 min, 150% for 10 min					
OUTPUT						
Nominal power [kVA]	30	40	60	80	100	120
Active power [kW]	30	40	60	80	100	120
Power factor	1 up to 40 °C					
Number of phases	3 + N					
Rated voltage [V]	380 ¹ / 400 / 415 three-phase + N (selectable)					
Rated frequency [Hz]	50 or 60					
Frequency stability on battery operation	0.01%					
Voltage stability	±1%					
Dynamic stability	EN 62040-3 class performance 1 non-linear load					
Voltage distortion	<1% with resistive linear load / ≤1.5% with non-linear load					
BATTERIES						
Type	VRLA AGM/GEL/NiCd/Li-ion/SuperCaps					
Recharging method	One level, Two level, Cyclic recharge (selectable)					
OVERALL SPECIFICATIONS						
Weight without batteries [kg]						
CPT - ACT - XTD (10-60)	N.A.-78-112	N.A.-82-116	N.A.-87-130		N.A.	
Weight [kg] S3T (80-120)	N.A.			172	180	198
Dimensions CPT (10-20) (WxDxH) [mm]	N.A.					
Dimensions ACT (10-60) (WxDxH) [mm]	Active: 380x850x1025			N.A.		
Dimensions XTD (10-60) (WxDxH) [mm]	Xtend: 440x840x1320			N.A.		
Dimensions S3T 80-120 (WxDxH) [mm]	N.A.			500x830x1600		
Communications	UPS status led bar - Graphic touch screen display - 2 slots for communications interface USB - RS232 - Contact interface with 5x opto insulated Input and 4x Output relays					
Ambient temperature for the UPS	0 °C - +40 °C					
Recommended temperature for battery life	+20 °C - +25 °C					
Range of relative humidity	5-95% non-condensing					
Colour	RAL 7016					
Noise level at 1 m [dBA ±2] SMART ACTIVE	<40		<50		<55	
IP rating	IP20					
SMART ACTIVE efficiency	up to 99%					
Standards	European directives: LV 2014/35/EU low voltage Directive EMC 2014/30/EU electromagnetic compatibility Directive Standards: Safety IEC EN 62040-1; EMC IEC EN 62040-2; RoHS compliant Classification in accordance with IEC EN 62040-3 (Voltage Frequency Independent) VFI - SS - 111					
Moving the UPS	Castors / pallet jack					

¹ For wider tolerance conditions apply.

^{BAT} Also available with internal batteries.

Note: S3T ACT 60 model is without internal batteries.



RPS SpA - Riello Power Solutions - Member of the Riello Elettronica Group

Viale Europa, 7 - 37045 Legnago (Verona) - ITALY - Tel: +39 0442 635811
www.riello-ups.com

